

1

2

3

4

5

6

A

B

C

D

E

A

B

C

D

E

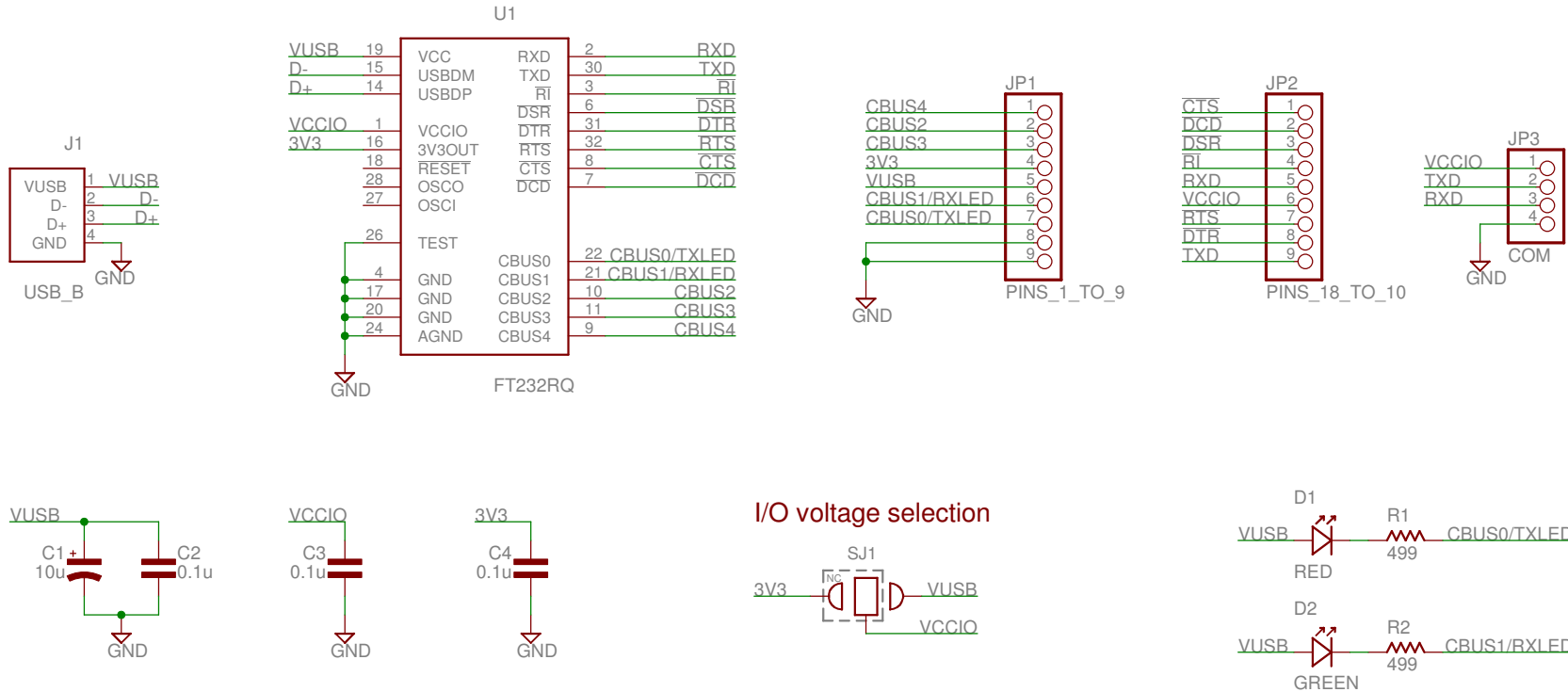

DIY embedded™

TITLE: FT232RL Breakout v1.0

Date: 12/13/2010 12:59:18 PM

Engineer:BB

Sheet: 1/1